Event Service Specification

October 2004
Version 1.2
formal/04-10-02



An Available Specification of the Object Management Group, Inc

Copyright 1993, DEC
Copyright 1993, Groupe Bull
Copyright 1993, Hewlett-Packard
Copyright 1993, HyperDesk
Copyright 1993, Itasca
Copyright 1993, Novell
Copyright 1993, O2
Copyright 1993, Object Design
Copyright 2000, Object Management Group, Inc.
Copyright 1993, Objectivity
Copyright 1993, Ontos
Copyright 1993, Oracle
Copyright 1993, Servio
Copyright 1993, SunSoft
Copyright 1993, Tivoli
Copyright 1993, Versant

USE OF SPECIFICATION - TERMS, CONDITIONS & NOTICES

The material in this document details an Object Management Group specification in accordance with the terms, conditions and notices set forth below. This document does not represent a commitment to implement any portion of this specification in any company's products. The information contained in this document is subject to change without notice.

LICENSES

The companies listed above have granted to the Object Management Group, Inc. (OMG) a nonexclusive, royalty-free, paid up, worldwide license to copy and distribute this document and to modify this document and distribute copies of the modified version. Each of the copyright holders listed above has agreed that no person shall be deemed to have infringed the copyright in the included material of any such copyright holder by reason of having used the specification set forth herein or having conformed any computer software to the specification.

Subject to all of the terms and conditions below, the owners of the copyright in this specification hereby grant you a fully-paid up, non-exclusive, nontransferable, perpetual, worldwide license (without the right to sublicense), to use this specification to create and distribute software and special purpose specifications that are based upon this specification, and to use, copy, and distribute this specification as provided under the Copyright Act; provided that: (1) both the copyright notice identified above and this permission notice appear on any copies of this specification; (2) the use of the specifications is for informational purposes and will not be copied or posted on any network computer or broadcast in any media and will not be otherwise resold or transferred for commercial purposes; and (3) no modifications are made to this specification. This limited permission automatically terminates without notice if you breach any of these terms or conditions. Upon termination, you will destroy immediately any copies of the specifications in your possession or control.

PATENTS

The attention of adopters is directed to the possibility that compliance with or adoption of OMG specifications may require use of an invention covered by patent rights. OMG shall not be responsible for identifying patents for which a license may be required by any OMG specification, or for conducting legal inquiries into the legal validity or scope of those patents that are brought to its attention. OMG specifications are prospective and advisory only. Prospective users are responsible for protecting themselves against liability for infringement of patents.

GENERAL USE RESTRICTIONS

Any unauthorized use of this specification may violate copyright laws, trademark laws, and communications regulations and statutes. This document contains information which is protected by copyright. All Rights Reserved. No part of this work covered by copyright herein may be reproduced or used in any form or by any means--graphic, electronic, or mechanical, including photocopying, recording, taping, or information storage and retrieval systems--without permission of the copyright owner.

DISCLAIMER OF WARRANTY

WHILE THIS PUBLICATION IS BELIEVED TO BE ACCURATE, IT IS PROVIDED "AS IS" AND MAY CONTAIN ERRORS OR MISPRINTS. THE OBJECT MANAGEMENT GROUP AND THE COMPANIES LISTED ABOVE MAKE NO WARRANTY OF ANY KIND, EXPRESS OR IMPLIED, WITH REGARD TO THIS PUBLICATION, INCLUDING BUT NOT LIMITED TO ANY WARRANTY OF TITLE OR OWNERSHIP, IMPLIED WARRANTY OF MERCHANTABILITY OR WARRANTY OF FITNESS FOR A PARTICULAR PURPOSE OR USE. IN NO EVENT SHALL THE OBJECT MANAGEMENT GROUP OR ANY OF THE COMPANIES LISTED ABOVE BE LIABLE FOR ERRORS CONTAINED HEREIN OR FOR DIRECT, INDIRECT, INCIDENTAL, SPECIAL, CONSEQUENTIAL, RELIANCE OR COVER DAMAGES, INCLUDING LOSS OF PROFITS, REVENUE, DATA OR USE, INCURRED BY ANY USER OR ANY THIRD PARTY IN CONNECTION WITH THE FURNISHING, PERFORMANCE, OR USE OF THIS MATERIAL, EVEN IF ADVISED OF THE POSSIBILITY OF SUCH DAMAGES.

The entire risk as to the quality and performance of software developed using this specification is borne by you. This disclaimer of warranty constitutes an essential part of the license granted to you to use this specification.

RESTRICTED RIGHTS LEGEND

Use, duplication or disclosure by the U.S. Government is subject to the restrictions set forth in subparagraph (c) (1) (ii) of The Rights in Technical Data and Computer Software Clause at DFARS 252.227-7013 or in subparagraph (c)(1) and (2) of the Commercial Computer Software - Restricted Rights clauses at 48 C.F.R. 52.227-19 or as specified in 48 C.F.R. 227-7202-2 of the DoD F.A.R. Supplement and its successors, or as specified in 48 C.F.R. 12.212 of the Federal Acquisition Regulations and its successors, as applicable. The specification copyright owners are as indicated above and may be contacted through the Object Management Group, 250 First Avenue, Needham, MA 02494, U.S.A.

TRADEMARKS

The OMG Object Management Group Logo®, CORBA®, CORBA Academy®, The Information Brokerage®, XMI® and IIOP® are registered trademarks of the Object Management Group. OMG™, Object Management Group™, CORBA logos™, OMG Interface Definition Language (IDL)™, The Architecture of Choice for a Changing World™, CORBA services™, CORBA facilities™, CORBAmed™, CORBA net™, Integrate 2002™, Middleware That's Everywhere™, UML™, Unified Modeling Language™, The UML Cube logo™, MOF™, CWM™, The CWM Logo™, Model Driven Architecture™, Model Driven Architecture Logos™, MDA™, OMG Model Driven Architecture™, OMG MDA™ and the XMI Logo™ are trademarks of the Object Management Group. All other products or company names mentioned are used for identification purposes only, and may be trademarks of their respective owners.

COMPLIANCE

The copyright holders listed above acknowledge that the Object Management Group (acting itself or through its designees) is and shall at all times be the sole entity that may authorize developers, suppliers and sellers of computer software to use certification marks, trademarks or other special designations to indicate compliance with these materials.

Software developed under the terms of this license may claim compliance or conformance with this specification if and only if the software compliance is of a nature fully matching the applicable compliance points as stated in the specification. Software developed only partially matching the applicable compliance points may claim only that the software was based on this specification, but may not claim compliance or conformance with this specification. In the event that testing suites are implemented or approved by Object Management Group, Inc., software developed using this specification may claim compliance or conformance with the specification only if the software satisfactorily completes the testing suites.

ISSUE REPORTING

All OMG specifications are subject to continuous review and improvement. As part of this process we encourage readers to report any ambiguities, inconsistencies, or inaccuracies they may find by completing the Issue Reporting Form listed on the main web page <http://www.omg.org>, under Documents & Specifications, Report a Bug/Issue.

OMG's Issue Reporting Procedure

All OMG specifications are subject to continuous review and improvement. As part of this process we encourage readers to report any ambiguities, inconsistencies, or inaccuracies they may find by completing the Issue Reporting Form listed on the main web page <http://www.omg.org>, under Documents, Report a Bug/Issue (<http://www.omg.org/technology/agreement.htm>).

Contents

Preface	iii
1. Service Description	1-1
1.1 Overview	1-1
1.2 Event Communication	1-2
1.3 Example Scenario	1-3
1.4 Design Principles	1-4
1.5 Resolution of Technical Issues	1-5
1.6 Quality of Service	1-6
1.7 Generic Event Communication	1-7
1.7.1 Push Model	1-7
1.7.2 Pull Model	1-7
2. Modules and Interfaces	2-1
2.1 The CosEventComm Module	2-1
2.1.1 The PushConsumer Interface	2-2
2.1.2 The PushSupplier Interface	2-2
2.1.3 The PullSupplier Interface	2-3
2.1.4 The PullConsumer Interface	2-3
2.1.5 Disconnection Behavior	2-4
2.2 Event Channels	2-4
2.2.1 Push-Style Communication with an Event Channel	2-4
2.2.2 Pull-Style Communication with an Event Channel	2-5

Contents

2.2.3	Mixed Style Communication with an Event Channel	2-5
2.2.4	Multiple Consumers and Multiple Suppliers	2-6
2.2.5	Event Channel Administration	2-6
2.3	The CosEventChannelAdmin Module	2-8
2.3.1	The EventChannel Interface	2-9
2.3.2	The ConsumerAdmin Interface	2-10
2.3.3	The SupplierAdmin Interface	2-10
2.3.4	The ProxyPushConsumer Interface	2-10
2.3.5	The ProxyPullSupplier Interface	2-11
2.3.6	The ProxyPullConsumer Interface	2-11
2.3.7	The ProxyPushSupplier Interface	2-12
2.4	Typed Event Communication	2-12
2.4.1	Typed Push Model	2-12
2.4.2	Typed Pull Model	2-13
2.5	The CosTypedEventComm Module	2-14
2.5.1	The TypedPushConsumer Interface	2-15
2.5.2	The TypedPullSupplier Interface	2-15
2.6	Typed Event Channels	2-16
2.7	The CosTypedEventChannelAdmin Module	2-16
2.7.1	The TypedEventChannel Interface	2-17
2.7.2	The TypedConsumerAdmin Interface	2-18
2.7.3	The TypedSupplierAdmin Interface	2-19
2.7.4	The TypedProxyPushConsumer Interface	2-19
2.7.5	The TypedProxyPullSupplier Interface	2-20
2.8	Composing Event Channels and Filtering	2-20
2.9	Policies for Finding Event Channels	2-20
	Appendix A - Implementing Typed Event Channels	A-1
	Appendix B - An Event Channel Use Example	B-1

Preface

About This Document

Under the terms of the collaboration between OMG and The Open Group, this document is a candidate for adoption by The Open Group, as an Open Group Technical Standard. The collaboration between OMG and The Open Group ensures joint review and cohesive support for emerging object-based specifications.

Object Management Group

The Object Management Group, Inc. (OMG) is an international organization supported by over 600 members, including information system vendors, software developers and users. Founded in 1989, the OMG promotes the theory and practice of object-oriented technology in software development. The organization's charter includes the establishment of industry guidelines and object management specifications to provide a common framework for application development. Primary goals are the reusability, portability, and interoperability of object-based software in distributed, heterogeneous environments. Conformance to these specifications will make it possible to develop a heterogeneous applications environment across all major hardware platforms and operating systems.

OMG's objectives are to foster the growth of object technology and influence its direction by establishing the Object Management Architecture (OMA). The OMA provides the conceptual infrastructure upon which all OMG specifications are based. More information is available at <http://www.omg.org/>.

Associated OMG Documents

The CORBA documentation is organized as follows:

-
- *Object Management Architecture Guide* defines the OMG's technical objectives and terminology and describes the conceptual models upon which OMG standards are based. It defines the umbrella architecture for the OMG standards. It also provides information about the policies and procedures of OMG, such as how standards are proposed, evaluated, and accepted.
 - CORBA Platform Technologies
 - *CORBA: Common Object Request Broker Architecture and Specification* contains the architecture and specifications for the Object Request Broker.
 - *CORBA Languages*, a collection of language mapping specifications. See the individual language mapping specifications.
 - *CORBA Services*, a collection of specifications for OMG's Object Services. See the individual service specifications.
 - *CORBA Facilities*, a collection of specifications for OMG's Common Facilities. See the individual facility specifications.
 - CORBA Domain Technologies
 - *CORBA Manufacturing*, a collection of specifications that relate to the manufacturing industry. This group of specifications defines standardized object-oriented interfaces between related services and functions.
 - *CORBA Med*, a collection of specifications that relate to the healthcare industry and represents vendors, healthcare providers, payers, and end users.
 - *CORBA Finance*, a collection of specifications that target a vitally important vertical market: financial services and accounting. These important application areas are present in virtually all organizations: including all forms of monetary transactions, payroll, billing, and so forth.
 - *CORBA Telecoms*, a collection of specifications that relate to the OMG-compliant interfaces for telecommunication systems.

The OMG collects information for each book in the documentation set by issuing Requests for Information, Requests for Proposals, and Requests for Comment and, with its membership, evaluating the responses. Specifications are adopted as standards only when representatives of the OMG membership accept them as such by vote. (The policies and procedures of the OMG are described in detail in the *Object Management Architecture Guide*.)

You may contact the Object Management Group, Inc. at:

OMG Headquarters
250 First Avenue
Needham, MA 02494
USA
Tel: +1-781-444-0404
Fax: +1-781-444-0320
pubs@omg.org
<http://www.omg.org>

Acknowledgments

The following companies submitted and/or supported parts of the *Event Service* specification:

- DEC
- Groupe Bull
- Hewlett-Packard
- HyperDesk
- Itasca
- Novell
- O2
- Object Design
- Object Management Group, Inc.
- Objectivity
- Ontos
- Oracle
- Servio
- SunSoft
- Tivoli
- Versant

Contents

This chapter contains the following topics.

Topic	Page
“Overview”	1-1
“Event Communication”	1-2
“Example Scenario”	1-3
“Design Principles”	1-4
“Resolution of Technical Issues”	1-5
“Quality of Service”	1-6
“Generic Event Communication”	1-7

1.1 Overview

A standard CORBA request results in the synchronous execution of an operation by an object. If the operation defines parameters or return values, data is communicated between the client and the server. A request is directed to a particular object. For the request to be successful, both the client and the server must be available. If a request fails because the server is unavailable, the client receives an exception and must take some appropriate action.

In some scenarios, a more decoupled communication model between objects is required. For example:

- A system administration tool is interested in knowing if a disk runs out of space. The software managing a disk is unaware of the existence of the system administration tool. The software simply reports that the disk is full. When a disk runs out of space, the system administration tool opens a window to inform the user which disk has run out of space.
- A property list object is associated with an application object. The property list object is physically separate from the application object. The application object is interested in the changes made to its properties by a user. The properties can be changed without involving the application object. That is, in order to have reasonable response time for the user, changing a property does not activate the application object. However, when the application object is activated, it needs to know about the changes to its properties.
- A CASE tool is interested in being notified when a source program has been modified. The source program simply reports when it is modified. It is unaware of the existence of the CASE tool. In response to the notification, the CASE tool invokes a compiler.
- Several documents are linked to a spreadsheet. The documents are interested in knowing when the value of certain cells have changed. When the cell value changes, the documents update their presentations based on the spreadsheet. Furthermore, if a document is unavailable because of a failure, it is still interested in any changes to the cells and wants to be notified of those changes when it recovers.

1.2 Event Communication

The Event Service decouples the communication between objects. The Event Service defines two roles for objects: the supplier role and the consumer role. *Suppliers* produce event data and *consumers* process event data. Event data are communicated between suppliers and consumers by issuing standard CORBA requests.

There are two approaches to initiating event communication between suppliers and consumers, and two orthogonal approaches to the form that the communication can take.

The two approaches to initiating event communication are called the *push model* and the *pull model*. The push model allows a supplier of events to initiate the transfer of the event data to consumers. The pull model allows a consumer of events to request the event data from a supplier. In the push model, the supplier is taking the initiative; in the pull model, the consumer is taking the initiative.

The communication itself can be either generic or typed. In the generic case, all communication is by means of generic `push` or `pull` operations that take a single parameter that packages all the event data. In the typed case, communication is via operations defined in OMG IDL. Event data is passed by means of the parameters, which can be defined in any manner desired.

An *event channel* is an intervening object that allows multiple suppliers to communicate with multiple consumers asynchronously. An event channel is both a consumer and a supplier of events. Event channels are standard CORBA objects and communication with an event channel is accomplished using standard CORBA requests.

1.3 Example Scenario

This section provides a general scenario that illustrates how the Event Service can be used.

The Event Service can be used to provide “change notification.” When an object is changed (its state is modified), an event can be generated that is propagated to all interested parties. For example, when a spreadsheet cell object is modified, all compound documents which contain a reference (link) to that cell can be notified (so the document can redisplay the referenced cell, or recalculate values that depend on the cell). Similarly, when an engineering specification object is modified, all engineers who have registered an interest in the specification can be notified that the specification has changed.

In this scenario, objects that can be “changed” act as suppliers, parties interested in receiving notifications of changes act as consumers, and one or more event channel objects are used as intermediaries between consumers and suppliers. *Either the push or the pull model can be used at either end.*

If the push model is used by suppliers, objects that can be changed support the **PushSupplier** interface so that event communication can be discontinued. Use the **EventChannel**, the **SupplierAdmin**, and the **ProxyPushConsumer** interfaces to register as suppliers of events, and use the **ProxyPushConsumer** interface to push events to event channels.

When a change occurs to an object, a changeable object invokes a push operation on the channel. It provides as an argument to the push operation information that describes the event. This information is of data type `any` - it can be as simple or as complex as is necessary. For example, the event information might identify the object reference of the object that has been changed, it might identify the kind of change that has occurred, it might provide a new displayable image of the changed object or it might identify one or more additional objects that describe the change that has been made.

If the pull model is used by consumers, all client objects that want to be notified of changes support the **PullConsumer** interface so communication can be discontinued, using the **EventChannel**, **ConsumerAdmin**, and **ProxyPullSupplier** interfaces to register as consumers of events, and using the **ProxyPullSupplier** interface to pull events from event channels.

The consumer may use either a blocking or non-blocking mechanism for receiving notification of changes. Using the `try_pull` operation, the consumer can periodically poll the channel for events. Alternatively, the consumer can use the `pull` operation which will block the consumer’s execution thread until an event is generated by some supplier.

Event channels act as the intermediaries between the objects being changed and objects interested in knowing about changes. The channels that provide change notification can be general purpose, well-known objects (e.g., “persistent server-based objects” that are run as part of a workgroup-wide framework of objects that provide “desktop services”) or specific-to-task objects (e.g., temporary objects that are created when needed). Objects that use event channels may locate the channels by looking for them in a persistently available server (e.g., by looking for them in a naming service) or they may be given references to these objects as part of a specific-to-task object protocol (e.g., when an “open” operation is invoked on an object, the object may return the reference to an event channel which the caller should use until the object is closed).

Event channels determine how changes are propagated between suppliers and consumers (i.e., the qualities of service). For example, an event channel determines the persistence of an event. The channel may keep an event for a specified period of time, passing it along to any consumer who registers with the channel during that period of time (e.g., it may keep event notifications about changes to engineering specifications for a week). Alternatively, the channel may only pass on events to consumers who are currently waiting for notification of changes (e.g., notifications of changes to a spreadsheet cell may only be sent to consumers who are currently displaying that cell).

This scenario exemplifies one way the event service described here forms a basic building block used in providing higher-level services specific to an application or common facilities framework of objects.

Instead of using the generic event channel, a typed event channel could also have been used.

1.4 Design Principles

The Event Service design satisfies the following principles:

- Events work in a distributed environment. The design does not depend on any global, critical, or centralized service.
- Event services allow multiple consumers of an event and multiple event suppliers.
- Consumers can either request events or be notified of events, whichever is more appropriate for application design and performance.
- Consumers and suppliers of events support standard OMG IDL interfaces; no extensions to CORBA are necessary to define these interfaces.
- A supplier can issue a single standard request to communicate event data to all consumers at once.
- Suppliers can generate events without knowing the identities of the consumers. Conversely, consumers can receive events without knowing the identities of the suppliers.
- The Event Service interfaces allow multiple qualities of service, for example, for different levels of reliability. It also allows for future interface extensions, such as for additional functionality.

- The Event Service interfaces are capable of being implemented and used in different operating environments, for example, in environments that support threading and those that do not.

1.5 Resolution of Technical Issues

This specification addresses the issues identified for event services in the OMG *Object Services Architecture*¹ document as follows:

- **Distributed environment:** The interfaces are designed to allow consumers and suppliers of events to be disconnected from time to time, and do not require centralized event identification, processing, routing, or other services that might be a bottleneck or a single point of failure.

Events themselves are *not* objects because the CORBA distributed object model does not support passing objects by value.

Event generation: The specification describes how events are generated and delivered in a very general fashion, with event channels as intermediate routing points. It does not require (or preclude) polling, nor does it require that an event supplier directly notify every interested party.

Events involving multiple objects: Complex events may be handled by constructing a notification tree of event consumer/suppliers checking for successively more specific event predicates. The specification does not require a general or global event predicate evaluation service as this may not be sufficiently reliable, efficient, or secure in a distributed, heterogeneous (potentially decoupled) environment.

Scoping, grouping, and filtering events: The specification takes advantage of CORBA's distributed scoping and grouping mechanisms for the identifier and type of events. Event filtering is easily achieved through event channels that selectively deliver events from suppliers to consumers. Event channels can be composed; that is, one event channel can consume events supplied by another. Typed event channels can provide filtering based on event type.

Registration and generation of events: Consumers and suppliers register with event channels themselves. Event channels are objects and they are found by any fashion that objects can be found. A global registration service is not required; any object that conforms to the IDL interface may consume an event.

Event parameters: The specification supports a parameter of type any that can be delivered with an event, used for application-specific data.

Forgery and secure events: Because event suppliers are objects, the specification leverages any ORB work on security for object references and communication.

1. *Object Services Architecture*, Document Number 92-8-4, Object Management Group, Framingham, MA, 1992.

Performance: The design is a minimalist one, and requires only one ORB call per event received. It supports both push-style and pull-style notification to avoid inefficient event polling. Since event suppliers, consumers, and channels are all ORB objects, the service directly benefits from a Library Object Adapter or any other ORB optimizations.

Formalized Event Information: For specific application environments and frameworks it may be beneficial to formalize the data associated with an event (defined in this specification as type any). This can be accomplished by defining a typed structure for this information. Depending on the needs of the environment, the kinds of information included might be a priority, timestamp, origin string, and confirmation indicator. This information might be solely for the benefit of the event consumer or might also be interpreted by particular event channel implementations.

Confirmation of Reception: Some applications may require that consumers of an event provide an explicit confirmation of reception back to the supplier. This can be supported effectively using a “reverse” event channel through which consumers send back confirmations as normal events. This obviates the need for any special confirmation mechanism. However, strict atomic delivery between all suppliers and all consumers requires additional interfaces.

1.6 *Quality of Service*

Application domains requiring event-style communication have diverse reliability requirements, from “at-most-once” semantics (best effort) to guaranteed “exactly-once” semantics, availability requirements, throughput requirements, performance requirements (i.e., how fast events are disseminated), and scalability requirements.

Clearly no single implementation of the Event Service can optimize such a diverse range of technical requirements. Hence, multiple implementations of event services are to be expected, with different services targeted toward different environments. As such, the event interfaces do not dictate *qualities of service*. Different implementations of the Event Service interfaces can support different qualities of service to meet different application needs.

For example, an implementation that trades at most once delivery to a single consumer in favor of performance is useful for some applications; an implementation that favors performance but cannot preclude duplicate delivery is useful for other applications. Both are acceptable implementations of the interfaces described in this chapter.

Clearly, an implementation of an event channel that discards all events is *not a useful* implementation. Useful implementations will at least support “best-effort” delivery of events.

Note that the interfaces defined in this chapter are incomplete for implementations that support strict notions of atomicity. That is, additional interfaces are needed by an implementation to guarantee that either all consumers receive an event or none of the consumers receive an event; and that all events are received in the same order by all consumers.

1.7 Generic Event Communication

There are two basic models for communicating event data between suppliers and consumers: the *push model* and the *pull model*.

1.7.1 Push Model

In the push model, suppliers “push” event data to consumers; that is, suppliers communicate event data by invoking `push` operations on the **PushConsumer** interface.

To set up a push-style communication, consumers and suppliers exchange **PushConsumer** and **PushSupplier** object references. Event communication can be broken by invoking a `disconnect_push_consumer` operation on the **PushConsumer** interface or by invoking a `disconnect_push_supplier` operation on the **PushSupplier** interface. If the **PushSupplier** object reference is nil, the connection cannot be broken via the supplier.

Figure 1-1 illustrates push-style communication between a supplier and a consumer.

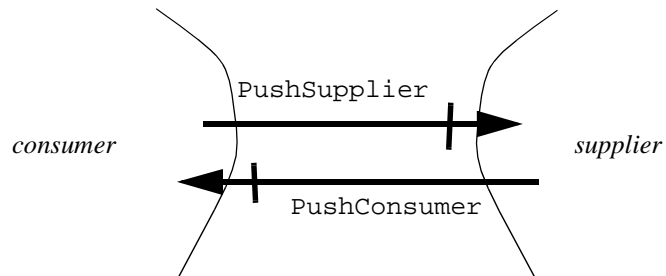

Figure 1-1 Push-style Communication Between a Supplier and a Consumer

1.7.2 Pull Model

In the pull model, consumers “pull” event data from suppliers; that is, consumers request event data by invoking `pull` operations on the **PullSupplier** interface.

To set up a pull-style communication, consumers and suppliers must exchange **PullConsumer** and **PullSupplier** object references. Event communication can be broken by invoking a `disconnect_pull_consumer` operation on the **PullConsumer** interface or by invoking a `disconnect_pull_supplier` operation on the **PullSupplier** interface. If the **PullConsumer** object reference is nil, the connection cannot be broken via the consumer.

Figure 1-2 illustrates pull-style communication between a supplier and a consumer.

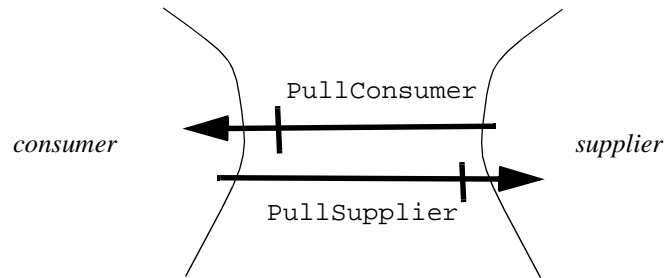

Figure 1-2 Pull-style Communication Between a Supplier and a Consumer

Contents

This chapter contains the following topics.

Topic	Page
“The CosEventComm Module”	2-1
“Event Channels”	2-4
“The CosEventChannelAdmin Module”	2-8
“Typed Event Communication”	2-12
“The CosTypedEventComm Module”	2-14
“Typed Event Channels”	2-16
“The CosTypedEventChannelAdmin Module”	2-16
“Composing Event Channels and Filtering”	2-20
“Policies for Finding Event Channels”	2-20

2.1 The CosEventComm Module

The communication styles shown in Chapter 1 are both supported by four simple interfaces: **PushConsumer**, **PushSupplier**, and **PullSupplier** and **PullConsumer**. These interfaces are defined in an OMG IDL module named **CosEventComm**, as shown below.

```
module CosEventComm {  
  
    exception Disconnected{};
```

```
interface PushConsumer {
    void push (in any data) raises(Disconnected);
    void disconnect_push_consumer();
};

interface PushSupplier {
    void disconnect_push_supplier();
};

interface PullSupplier {
    any pull () raises(Disconnected);
    any try_pull (out boolean has_event)
        raises(Disconnected);
    void disconnect_pull_supplier();
};

interface PullConsumer {
    void disconnect_pull_consumer();
};

};
```

2.1.1 The *PushConsumer* Interface

A push-style consumer supports the **PushConsumer** interface to receive event data.

```
interface PushConsumer {
    void push (in any data) raises(Disconnected);
    void disconnect_push_consumer();
};
```

A supplier communicates event data to the consumer by invoking the **push** operation and passing the event data as a parameter.

The **disconnect_push_consumer** operation terminates the event communication; it releases resources used at the consumer to support the event communication. The *PushConsumer* object reference is disposed. Calling **disconnect_push_consumer** causes the implementation to call the **disconnect_push_supplier** operation on the corresponding **PushSupplier** interface (if that interface is known).

2.1.2 The *PushSupplier* Interface

A push-style supplier supports the **PushSupplier** interface.

```
interface PushSupplier {
    void disconnect_push_supplier();
};
```

The **disconnect_push_supplier** operation terminates the event communication; it releases resources used at the supplier to support the event communication. The *PushSupplier* object reference is disposed. Calling **disconnect_push_supplier** causes the implementation to call the **disconnect_push_consumer** operation on the corresponding **PushConsumer** interface (if that interface is known).

2.1.3 The PullSupplier Interface

A pull-style supplier supports the **PullSupplier** interface to transmit event data.

```
interface PullSupplier {
    any pull () raises(Disconnected);
    any try_pull (out boolean has_event)
        raises(Disconnected);
    void disconnect_pull_supplier();
};
```

A consumer requests event data from the supplier by invoking either the **pull** operation or the **try_pull** operation on the supplier.

- The **pull** operation blocks until the event data is available or an exception is raised.¹ It returns the event data to the consumer.
- The **try_pull** operation does not block: if the event data is available, it returns the event data and sets the **has_event** parameter to *true*; if the event is not available, it sets the **has_event** parameter to *false* and the event data is returned as long with an undefined value.

The **disconnect_pull_supplier** operation terminates the event communication; it releases resources used at the supplier to support the event communication. The **PullSupplier** object reference is disposed. Calling **disconnect_pull_supplier** causes the implementation to call the **disconnect_pull_consumer** operation on the corresponding **PullConsumer** interface (if that interface is known).

2.1.4 The PullConsumer Interface

A pull-style consumer supports the **PullConsumer** interface.

```
interface PullConsumer {
    void disconnect_pull_consumer();
};
```

The **disconnect_pull_consumer** operation terminates the event communication; it releases resources used at the consumer to support the event communication.

The **PullConsumer** object reference is disposed. Calling **disconnect_pull_consumer** causes the implementation to call the **disconnect_pull_supplier** operation on the corresponding **PullSupplier** interface (if that interface is known).

2.1.5 Disconnection Behavior

Calling a disconnect operation on a consumer or supplier interface may cause a call to the corresponding disconnect operation on the connected supplier or consumer. Implementations must take care to avoid infinite recursive calls to these disconnect

¹ This, of course, may be a standard CORBA exception.

operations. If a consumer or supplier has received a disconnect call and subsequently receives another disconnect call, it shall raise a `CORBA::OBJECT_NOT_EXIST` exception.

2.2 Event Channels

The *event channel* is a service that decouples the communication between suppliers and consumers. The event channel is itself both a consumer and a supplier of the event data.

An event channel can provide asynchronous communication of event data between suppliers and consumers. Although consumers and suppliers communicate with the event channel using standard CORBA requests, the event channel does not need to supply the event data to its consumer at the same time it consumes the data from its supplier.

2.2.1 Push-Style Communication with an Event Channel

The supplier pushes event data to the event channel; the event channel, in turn, pushes event data to the consumer. Figure 2-1 illustrates a push-style communication between a supplier and the event channel, and a consumer and the event channel.

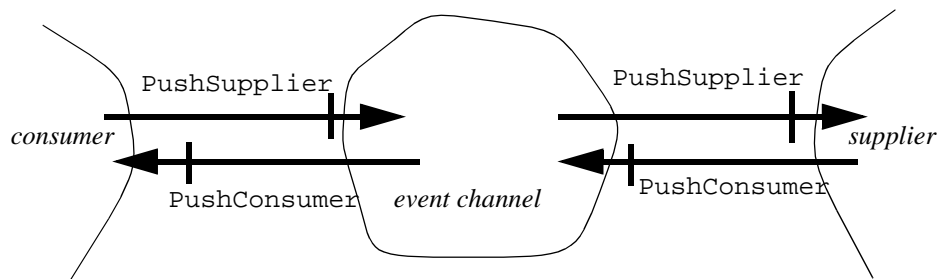

Figure 2-1 Push-style Communication Between a Supplier and an Event Channel, and a Consumer and an Event Channel

2.2.2 Pull-Style Communication with an Event Channel

The consumer pulls event data from the event channel; the event channel, in turn, pulls event data from the supplier. Figure 2-2 illustrates a pull-style communication between a supplier and the event channel, and a consumer and the event channel.

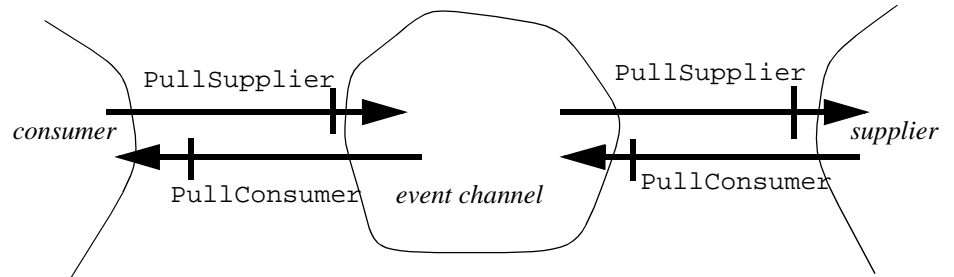

Figure 2-2 Pull-style communication between a supplier and an event channel and a consumer and the event channel

2.2.3 Mixed Style Communication with an Event Channel

An event channel can communicate with a supplier using one style of communication, and communicate with a consumer using a different style of communication.

Figure 2-3 illustrates a push-style communication between a supplier and an event channel, and a pull-style communication between a consumer and the event channel. The consumer pulls the event data that the supplier has pushed to the event channel.

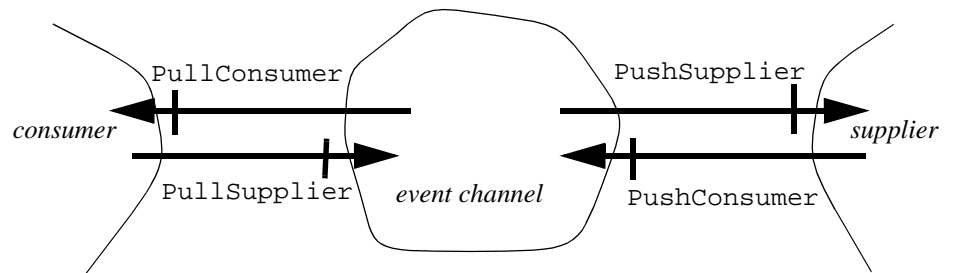

Figure 2-3 Push-style Communication Between a Supplier and an Event Channel, and Pull-style Communication Between a Consumer and an Event Channel

2.2.4 Multiple Consumers and Multiple Suppliers

Figure 2-1, Figure 2-2, and Figure 2-3 illustrate event channels with a single supplier and a single consumer. An event channel can also provide many-to-many communication. The channel consumes events from one or more suppliers, and supplies events to one or more consumers. Subject to the quality of service of a particular implementation, an event channel provides an event to all consumers.

Figure 2-4 illustrates an event channel with multiple push-style consumers and multiple push-style suppliers.

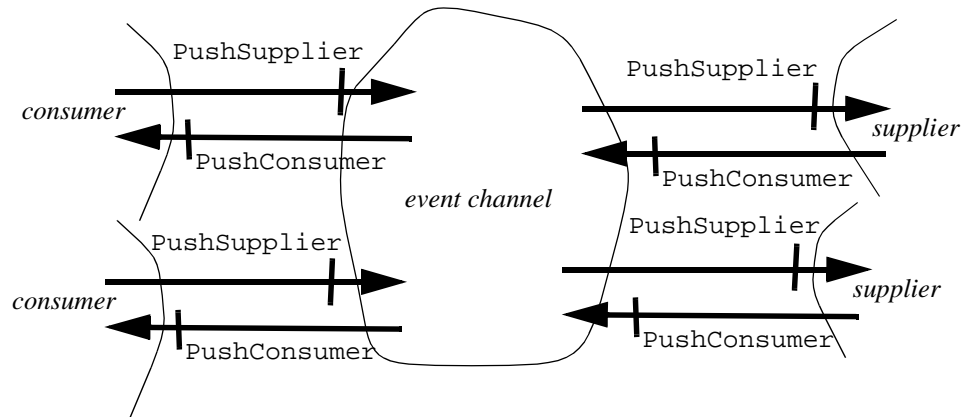

Figure 2-4 An Event Channel with Multiple Suppliers and Multiple Consumers

An event channel can support consumers and suppliers using different communication models.

If an event channel has pull suppliers, it continues to pull events from the suppliers, regardless of whether any consumers are connected to the channel.

2.2.5 Event Channel Administration

The event channel is built up incrementally. When an event channel is created, no suppliers or consumers are connected to the event channel. Upon creation of the channel, the factory returns an object reference that supports the **EventChannel** interface, as illustrated in Figure 2-5.

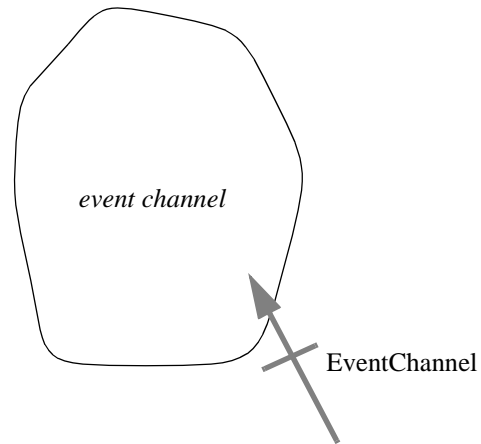

Figure 2-5 A newly created event channel. The channel has no suppliers or consumers.

The **EventChannel** interface defines three administrative operations: an operation returning a **ConsumerAdmin** object for adding consumers, an operation returning a **SupplierAdmin** object for adding suppliers, and an operation for destroying the channel.

The operations for adding consumers return *proxy suppliers*. A proxy supplier is similar to a normal supplier (in fact, it inherits the interface of a supplier), but includes an additional method for connecting a consumer to the proxy supplier.

The operations for adding suppliers return *proxy consumers*. A proxy consumer is similar to a normal consumer (in fact, it inherits the interface of a consumer), but includes an additional method for connecting a supplier to the proxy consumer.

Registration of a producer or consumer is a two step process. An event-generating application first obtains a proxy consumer from a channel, then “connects” to the proxy consumer by providing it with a supplier. Similarly, an event-receiving application first obtains a proxy supplier from a channel, then “connects” to the proxy supplier by providing it with a consumer.

The reason for the two-step registration process is to support composing event channels by an external agent. Such an agent would compose two channels by obtaining a proxy supplier from one and a proxy consumer from the other, and passing each of them a reference to the other as part of their connect operation.

Proxies are in one of three states: *disconnected*, *connected*, or *destroyed*. Figure 2-6 gives a state diagram for a proxy. The nodes of the diagram are the states and the edges are labelled with the operations that change the state of the proxy. **Push/pull** operations are only valid in the *connected* state.

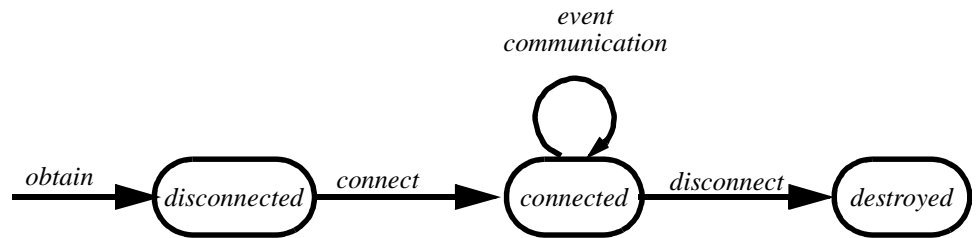

Figure 2-6 State diagram of a proxy.

2.3 The *CosEventChannelAdmin* Module

The **CosEventChannelAdmin** module defines the interfaces for making connections between suppliers and consumers. The **CosEventChannelAdmin** module is defined below.

```

#include "CosEventComm.idl"

module CosEventChannelAdmin {

    exception AlreadyConnected {};
    exception TypeError {};

    interface ProxyPushConsumer: CosEventComm::PushConsumer {
        void connect_push_supplier(
            in CosEventComm::PushSupplier push_supplier)
            raises(AlreadyConnected);
    };

    interface ProxyPullSupplier: CosEventComm::PullSupplier {
        void connect_pull_consumer(
            in CosEventComm::PullConsumer pull_consumer)
            raises(AlreadyConnected);
    };

    interface ProxyPullConsumer: CosEventComm::PullConsumer {
        void connect_pull_supplier(
            in CosEventComm::PullSupplier pull_supplier)
            raises(AlreadyConnected,TypeError);
    };

    interface ProxyPushSupplier: CosEventComm::PushSupplier {
        void connect_push_consumer(
            in CosEventComm::PushConsumer push_consumer)
  
```

```

        raises(AlreadyConnected, TypeError);
    };

    interface ConsumerAdmin {
        ProxyPushSupplier obtain_push_supplier();
        ProxyPullSupplier obtain_pull_supplier();
    };

    interface SupplierAdmin {
        ProxyPushConsumer obtain_push_consumer();
        ProxyPullConsumer obtain_pull_consumer();
    };

    interface EventChannel {
        ConsumerAdmin for_consumers();
        SupplierAdmin for_suppliers();
        void destroy();
    };
};

```

2.3.1 The EventChannel Interface

The **EventChannel** interface defines three administrative operations: adding consumers, adding suppliers, and destroying the channel.

```

interface EventChannel {
    ConsumerAdmin for_consumers();
    SupplierAdmin for_suppliers();
    void destroy();
};

```

Any object that possesses an object reference that supports the **EventChannel** interface can perform these operations:

- The **ConsumerAdmin** interface allows consumers to be connected to the event channel. The **for_consumers** operation returns an object reference that supports the **ConsumerAdmin** interface.
- The **SupplierAdmin** interface allows suppliers to be connected to the event channel. The **for_suppliers** operation returns an object reference that supports the **SupplierAdmin** interface.
- The **destroy** operation destroys the event channel. Destroying an event channel destroys all **ConsumerAdmin** and **SupplierAdmin** objects that were created via that channel. Destruction of a **ConsumerAdmin** or **SupplierAdmin** object causes the implementation to invoke the disconnect operation on all proxies that were created via that **ConsumerAdmin** or **SupplierAdmin** object.

Consumer administration and supplier administration are defined as separate objects so that the creator of the channel can control the addition of suppliers and consumers. For example, a creator might wish to be the sole supplier of event data but allow many consumers to be connected to the channel. In such a case, the creator would simply export the **ConsumerAdmin** object.

2.3.2 *The ConsumerAdmin Interface*

The **ConsumerAdmin** interface defines the first step for connecting consumers to the event channel; clients use it to obtain proxy suppliers.

```
interface ConsumerAdmin {
    ProxyPushSupplier obtain_push_supplier();
    ProxyPullSupplier obtain_pull_supplier();
};
```

The **obtain_push_supplier** operation returns a **ProxyPushSupplier** object. The **ProxyPushSupplier** object is then used to connect a push-style consumer.

The **obtain_pull_supplier** operation returns a **ProxyPullSupplier** object. The **ProxyPullSupplier** object is then used to connect a pull-style consumer.

2.3.3 *The SupplierAdmin Interface*

The **SupplierAdmin** interface defines the first step for connecting suppliers to the event channel; clients use it to obtain proxy consumers.

```
interface SupplierAdmin {
    ProxyPushConsumer obtain_push_consumer();
    ProxyPullConsumer obtain_pull_consumer();
};
```

The **obtain_push_consumer** operation returns a **ProxyPushConsumer** object. The **ProxyPushConsumer** object is then used to connect a push-style supplier.

The **obtain_pull_consumer** operation returns a **ProxyPullConsumer** object. The **ProxyPullConsumer** object is then used to connect a pull-style supplier.

2.3.4 *The ProxyPushConsumer Interface*

The **ProxyPushConsumer** interface defines the second step for connecting push suppliers to the event channel.

```
interface ProxyPushConsumer: CosEventComm::PushConsumer {
    void connect_push_supplier(
        in CosEventComm::PushSupplier push_supplier)
        raises(AlreadyConnected);
};
```

A nil object reference may be passed to the **connect_push_supplier** operation; if so a channel cannot invoke the **disconnect_push_supplier** operation on the supplier; the supplier may be disconnected from the channel without being informed. If a non-nil reference is passed to **connect_push_supplier**, the implementation calls **disconnect_push_supplier** via that reference when the **ProxyPushConsumer** is destroyed.

If the **ProxyPushConsumer** is already connected to a **PushSupplier**, then the **AlreadyConnected** exception is raised.

2.3.5 The ProxyPullSupplier Interface

The **ProxyPullSupplier** interface defines the second step for connecting pull consumers to the event channel.

```
interface ProxyPullSupplier: CosEventComm::PullSupplier {
    void connect_pull_consumer(
        in CosEventComm::PullConsumer pull_consumer)
        raises(AlreadyConnected);
};
```

A nil object reference may be passed to the **connect_pull_consumer** operation; if so a channel cannot invoke a **disconnect_pull_consumer** operation on the consumer; the consumer may be disconnected from the channel without being informed. If a non-nil reference is passed to **connect_pull_consumer**, the implementation calls **disconnect_pull_consumer** via that reference when the **ProxyPullSupplier** is destroyed.

If the **ProxyPullSupplier** is already connected to a **PullConsumer**, then the **AlreadyConnected** exception is raised.

2.3.6 The ProxyPullConsumer Interface

The **ProxyPullConsumer** interface defines the second step for connecting pull suppliers to the event channel.

```
interface ProxyPullConsumer: CosEventComm::PullConsumer {
    void connect_pull_supplier(
        in CosEventComm::PullSupplier pull_supplier)
        raises(AlreadyConnected, TypeError);
};
```

The implementation calls **disconnect_pull_supplier** on the reference passed to **connect_pull_supplier** when the **ProxyPullConsumer** is destroyed.

Implementations shall raise the CORBA standard **BAD_PARAM** exception if a nil object reference is passed to the **connect_pull_supplier** operation.

If the **ProxyPullConsumer** is already connected to a **PullSupplier**, then the **AlreadyConnected** exception is raised.

An implementation of a **ProxyPullConsumer** may put additional requirements on the interface supported by the pull supplier. If the pull supplier does not meet those requirements, the **ProxyPullConsumer** raises the **TypeError** exception. (See Section 2.5.2, “The TypedPullSupplier Interface,” on page 2-15 for an example.)

2.3.7 The ProxyPushSupplier Interface

The **ProxyPushSupplier** interface defines the second step for connecting push consumers to the event channel.

```
interface ProxyPushSupplier: CosEventComm::PushSupplier {
    void connect_push_consumer(
        in CosEventComm::PushConsumer push_consumer)
        raises(AlreadyConnected, TypeError);
};
```

The implementation calls **disconnect_push_consumer** on the reference passed to **connect_push_consumer** when the **ProxyPushSupplier** is destroyed.

Implementations shall raise the CORBA standard **BAD_PARAM** exception if a nil object reference is passed to the **connect_push_consumer** operation.

If the **ProxyPushSupplier** is already connected to a **PushConsumer**, then the **AlreadyConnected** exception is raised.

An implementation of a **ProxyPushSupplier** may put additional requirements on the interface supported by the push consumer. If the push consumer does not meet those requirements, the **ProxyPushSupplier** raises the **TypeError** exception. (See Section 2.5.1, “The TypedPushConsumer Interface,” on page 2-15 for an example.)

2.4 Typed Event Communication

Section 1.7, “Generic Event Communication,” on page 1-7 discusses generic event communication using **push** and **pull** operations. The next few sections describe how event communication can be described in OMG IDL and how typed event channels can support such typed event communication.

2.4.1 Typed Push Model

In the typed push model, suppliers call operations on consumers using some mutually agreed interface **I**. The interface **I** is defined in IDL, and may contain any operations subject to the following restrictions:

- All parameters must be in parameters only.
- No return values are permitted

These are the same restrictions as CORBA imposes on **oneway** operations, and for similar reasons: event communication is unidirectional, and does not directly support responses. The operations can be declared **oneway**, but need not be. (Note that, if a

consumer operation is declared **oneway**, there is no way for the caller to find out if the consumer is in the disconnected state because, for **oneway** calls, the servant cannot raise exceptions.

To set up typed push-style communication, consumers and suppliers exchange **TypedPushConsumer** and **PushSupplier** object references. (Note that the supplier interface is the same as the untyped case.) The supplier then invokes the **get_typed_consumer** operation of the **TypedPushConsumer** interface, which returns an object reference supporting the typed interface, **I**, referred to as an **I-reference**. The particular interface, **I**, that the reference supports is dependent on the particular **TypedPushConsumer**, and must be mutually agreed by supplier and consumer. Once the supplier has obtained the **I-reference**, it can call operations in interface **I** on the consumer.

As in the case of the generic push-style, event communication can be broken by invoking a **disconnect_push_consumer** operation on the **TypedPushConsumer** interface or by invoking a **disconnect_push_supplier** operation on the **PushSupplier** interface. If the **PushSupplier** object reference is nil, the connection cannot be broken via the supplier.

Figure 2-7 illustrates typed push-style communication between supplier and consumer.

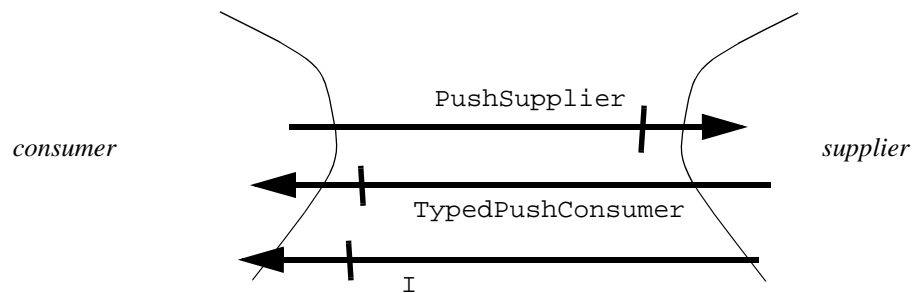

Figure 2-7 Typed Push-style Communication Between a Supplier and a Consumer

2.4.2 Typed Pull Model

In the typed pull model, consumers call operations on suppliers, requesting event information, using some mutually agreed interface **Pull<I>**². For every interface **I** having the properties described in Section 2.4.1, “Typed Push Model,” on page 2-12, an interface **Pull<I>** is defined as follows:

- For every operation **o** in **I**, **Pull<I>** contains two operations:
 - **pull_o**, with all **in** parameters changed to **out** parameters. When called, this operation will return with the event data in the **out** parameters. If no **o**-event is currently available, it will block.

2. **Pull<I>** is used as notation for a computed interface from interface **I**. Thus, if **I** is an interface **DocumentEvents**, **Pull<I>** is an interface **PullDocumentEvents**.

- **boolean try_o**, with all in parameters changed to out parameters. When called, this operation will check whether an **o**-event is currently available. If so, it will return *true*, with the event data in the *out* parameters. If not, it will return *false*, with the out parameters undefined

The interface **Pull<I>** is designed to allow pulling of exactly the same events that can be pushed using interface **I**.

To set up typed pull-style communication, consumers and suppliers exchange **PullConsumer** and **TypedPullSupplier** object references. (Note that the consumer interface is the same as the untyped case.) The consumer then invokes the **get_typed_supplier** operation of the **TypedPullSupplier**, which returns an object reference supporting the typed interface, **Pull<I>**, referred to as a **Pull<I>-reference**. The particular interface, **Pull<I>**, that the reference supports is dependent on the particular **TypedPullSupplier**, and must be mutually agreed by supplier and consumer. Once the consumer has obtained the **Pull<I>-reference**, it can call operations in interface **Pull<I>** on the supplier.

Figure 2-8 illustrates typed pull-style communication between supplier and consumer.

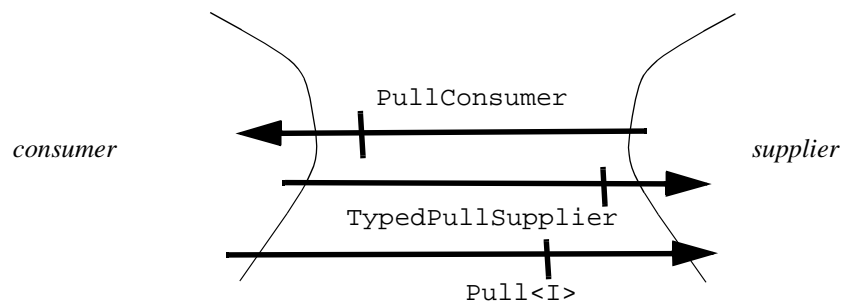

Figure 2-8 Typed Pull-style Communication Between a Supplier and a Consumer

2.5 The *CosTypedEventComm* Module

The typed communication styles shown in Figure 2-7 and Figure 2-8 are both supported by two new interfaces, **TypedPushConsumer** and **TypedPullSupplier** and two existing interfaces, **PushSupplier** and **PullConsumer**. The first two interfaces are defined in an OMG IDL module named **CosTypedEventComm**, as shown below. The last two are the same as for untyped event communication, and were defined in the **CosEventComm** module.

```
#include "CosEventComm.idl"

module CosTypedEventComm {

    interface TypedPushConsumer : CosEventComm::PushConsumer {
        Object get_typed_consumer();
    };
};
```

```

        interface TypedPullSupplier : CosEventComm::PullSupplier {
            Object get_typed_supplier();
        };
};

```

2.5.1 The TypedPushConsumer Interface

A typed push-style consumer supports the **TypedPushConsumer** interface both to receive event data in the generic manner, and to supply a specific typed interface through which to receive it in typed form.

```

        interface TypedPushConsumer : CosEventComm::PushConsumer {
            Object get_typed_consumer();
        };

```

The **TypedPushConsumer** can behave just like an untyped **PushConsumer**, described in Section 2.1.1, “The PushConsumer Interface,” on page 2-2. In addition, if the supplier wishes to communicate event data to the consumer in typed rather than generic form, it first invokes the **get_typed_consumer** operation. This returns an **I-reference** supporting an interface **I**. The particular interface **I** that the reference supports is dependent on the particular **TypedPushConsumer**. The return type of the operation is **Object**, because different **TypedPushConsumer**s will return references of different types, so the actual type cannot be specified in a general definition. Once the supplier has obtained the **I-reference**, it can narrow it to **I**, and then call operations in interface **I** on the consumer. Mutual agreement about **I** is needed between the supplier and consumer. If they do not agree, the narrow operation will fail.

As noted above, a **TypedPushConsumer** must support the **push** operation, inherited from **CosEventComm::PushConsumer**. Implementing **push** fully is an unnecessary burden if the consumer is intended for typed use only. It is therefore permissible to implement a **TypedPushConsumer** with a null implementation of **push** that merely raises the standard CORBA exception **NO_IMPLEMENT**. Clearly, suppliers must know this and confine themselves to typed communication with such consumers.

If a **TypedPushConsumer** is in the disconnected state and a supplier attempts to deliver a typed event, the consumer shall raise a **BAD_INV_ORDER** exception.

2.5.2 The TypedPullSupplier Interface

A typed pull-style supplier supports the **TypedPullSupplier** interface both to allow consumers to pull event data in the generic manner, and to supply a specific typed interface through which they can pull it in typed form.

```

        interface TypedPullSupplier : CosEventComm::PullSupplier {
            Object get_typed_supplier();
        };

```

The **TypedPullSupplier** can behave just like an untyped **PullSupplier**, described in Section 2.1.3, “The PullSupplier Interface,” on page 2-3. In addition, if the consumer wishes to pull event data from the supplier in typed rather than generic form, it first invokes the **get_typed_supplier** operation. This returns a **Pull<I>-reference** supporting an interface **Pull<I>**. The particular interface, **Pull<I>**, that the reference supports is dependent on the particular **TypedPullSupplier**. The return type of the operation is **Object**, because different **TypedPullSuppliers** will return references of different types, so the actual type cannot be specified in a general definition. Once the consumer has obtained the **Pull<I>-reference**, it can narrow it to **Pull<I>**, and then call operations in interface **Pull<I>** on the supplier. Mutual agreement about **Pull<I>** is needed between the supplier and consumer. If they do not agree, the **narrow** operation will fail.

As noted above, a **TypedPullSupplier** must support the **pull** and **try_pull** operations, inherited from **CosEventComm::PullSupplier**. Implementing these operations fully is an unnecessary burden if the supplier is intended for typed use only. It is therefore permissible to implement a **TypedPullSupplier** with null implementations of **pull** and **try_pull** that merely raise the standard CORBA exception **NO_IMPLEMENT**. Clearly, consumers must know this and confine themselves to typed communication with such suppliers.

If a **TypedPullSupplier** is in the disconnected state and a consumer attempts to retrieve a typed event, the supplier shall raise a **BAD_INV_ORDER** exception.

2.6 Typed Event Channels

Typed event channels are analogous to generic event channels, but they support both typed and generic event communication. These forms can be mixed at will. A single channel can handle events supplied and consumed in any combination of the forms defined earlier (push/pull, generic/typed). An event supplied in typed form can be consumed in generic form, or vice versa.³

2.7 The CosTypedEventChannelAdmin Module

The **CosTypedEventChannelAdmin** module defines the interfaces for making connections between suppliers and consumers that use either generic or typed communication. Most of its interfaces are specializations of the corresponding interfaces in the **CosEventChannel** module.

```
#include "CosEventChannel.idl"
#include "CosTypedEventComm.idl"

module CosTypedEventChannelAdmin {
```

3. Doing this does require an understanding on the part of the generic suppliers and consumers of how the channel packages parameters of typed calls when converting them to generic form. Details of this packaging are dependent on the implementation of the channel.

```

exception InterfaceNotSupported {};
exception NoSuchImplementation {};
typedef string Key; // Repository ID

interface TypedProxyPushConsumer :
    CosEventChannelAdmin::ProxyPushConsumer,
    CosTypedEventComm::TypedPushConsumer {};

interface TypedProxyPullSupplier :
    CosEventChannelAdmin::ProxyPullSupplier,
    CosTypedEventComm::TypedPullSupplier {};

interface TypedSupplierAdmin :
    CosEventChannelAdmin::SupplierAdmin {
    TypedProxyPushConsumer obtain_typed_push_consumer(
        in Key supported_interface)
    raises(InterfaceNotSupported);
    ProxyPullConsumer obtain_typed_pull_consumer (
        in Key uses_interface)
    raises(NoSuchImplementation);
};

interface TypedConsumerAdmin :
    CosEventChannelAdmin::ConsumerAdmin {
    TypedProxyPullSupplier obtain_typed_pull_supplier(
        in Key supported_interface)
    raises (InterfaceNotSupported);
    ProxyPushSupplier obtain_typed_push_supplier(
        in Key uses_interface)
    raises(NoSuchImplementation);
};

interface TypedEventChannel {
    TypedConsumerAdmin for_consumers();
    TypedSupplierAdmin for_suppliers();
    void destroy ();
};
};

```

2.7.1 The TypedEventChannel Interface

```

interface TypedEventChannel {
    TypedConsumerAdmin for_consumers();
    TypedSupplierAdmin for_suppliers();
    void destroy ();
};

```

This interface is analogous to **CosEventChannelAdmin::EventChannel**. However, it returns typed versions of the consumer and supplier administration interfaces, which are capable of providing proxies for either generic or typed communication.

2.7.2 The *TypedConsumerAdmin* Interface

The **TypedConsumerAdmin** interface defines the first step for connecting consumers to typed event channel; clients use it to obtain proxy suppliers.

```
interface TypedConsumerAdmin :
    CosEventChannelAdmin::ConsumerAdmin {
        TypedProxyPullSupplier obtain_typed_pull_supplier(
            in Key supported_interface)
            raises (InterfaceNotSupported);
        ProxyPushSupplier obtain_typed_push_supplier(
            in Key uses_interface)
            raises(NoSuchImplementation);
    };
```

The **obtain_typed_pull_supplier** operation takes a **Key** parameter that identifies an interface, **Pull<I>**. The key specifies the repository ID of the supported interface. The scope of the key is the typed event channel. It returns a **TypedProxyPullSupplier** for interface **Pull<I>**. The **TypedProxyPullSupplier** will allow an attached pull consumer to pull events either in generic form or using operations in interface **Pull<I>**. It is up to the implementation of **obtain_typed_pull_supplier** to create or find an appropriate **TypedProxyPullSupplier**. If it cannot, it raises the exception **InterfaceNotSupported**.

The **obtain_typed_push_supplier** operation takes a **Key** parameter that identifies an interface, **I**. The key specifies the repository ID of the interface used. The scope of the key is the typed event channel. It returns a **ProxyPushSupplier** that calls operations in interface **I**, rather than **push** operations. It is up to the implementation of **obtain_typed_push_supplier** to create or find an appropriate **ProxyPushSupplier**⁴. If it cannot, it raises the exception **NoSuchImplementation**.

Such a **ProxyPushSupplier** is guaranteed only to invoke operations defined in interface **I**. Any event on the channel that does not correspond to an operation defined in interface **I** is not passed on to the consumer. Such a **ProxyPushSupplier** is therefore an event filter based on type.

4. See Appendix A for implementation considerations.

2.7.3 The *TypedSupplierAdmin* Interface

The **TypedSupplierAdmin** interface defines the first step for connecting suppliers to the typed event channel; clients use it to obtain proxy consumers.

```
interface TypedSupplierAdmin :
    CosEventChannelAdmin::SupplierAdmin {
        TypedProxyPushConsumer obtain_typed_push_consumer(
            in Key supported_interface)
            raises(InterfaceNotSupported);
        ProxyPullConsumer obtain_typed_pull_consumer (
            in Key uses_interface)
            raises(NoSuchImplementation);
    };
```

The **obtain_typed_push_consumer** operation takes a **Key** parameter that identifies an interface, **I**. The key specifies the repository ID of the supported interface. The scope of the key is the typed event channel. It returns a **TypedProxyPushConsumer** for **I**. An attached supplier can provide events by using operations in interface **I**. It is up to the implementation of **obtain_typed_push_consumer** to create or find an appropriate **TypedProxyPushConsumer**. If it cannot, it raises the exception **InterfaceNotSupported**.

The **obtain_typed_pull_consumer** operation takes a **Key** parameter that identifies an interface, **Pull<I>**. The key specifies the repository ID of the interface used. The scope of the key is the typed event channel. It returns a **ProxyPullConsumer** that calls operations in interface **Pull<I>**, rather than **pull** operations. It is up to the implementation of **obtain_typed_pull_consumer** to create or find an appropriate **ProxyPullConsumer**. If it cannot, it raises the exception **NoSuchImplementation**.

Such a **ProxyPullConsumer** is guaranteed only to invoke operations defined in interface **Pull<I>**. Any event request that does not correspond to an operation defined in interface **Pull<I>** is not pulled from the supplier. Such a **ProxyPullConsumer** is therefore an event filter based on type.

2.7.4 The *TypedProxyPushConsumer* Interface

The **TypedProxyPushConsumer** interface defines the second step for connecting push suppliers to the typed event channel.

```
interface TypedProxyPushConsumer :
    CosEventChannelAdmin::ProxyPushConsumer,
    CosTypedEventComm::TypedPushConsumer { };
```

By inheriting from both **CosEventChannelAdmin::ProxyPushConsumer** and **CosTypedEventComm::TypedPushConsumer**, this interface supports:

- connection and disconnection of push suppliers, exactly as in the generic event channel,
- generic **push** operation, and

- obtaining the typed view, so that the supplier can use typed push communication. The reference returned by **get_typed_consumer** has the interface identified by the **Key** used when this **TypedProxyPushConsumer** was obtained. (See Section 2.7.3, “The TypedSupplierAdmin Interface,” on page 2-19.)

2.7.5 The TypedProxyPullSupplier Interface

The **TypedProxyPullSupplier** interface defines the second step for connecting pull consumers to the typed event channel.

```
interface TypedProxyPullSupplier :
    CosEventChannelAdmin::ProxyPullSupplier,
    CosTypedEventComm::TypedPullSupplier { };
```

By inheriting from both **CosEventChannelAdmin::ProxyPullSupplier** and **CosTypedEventComm::TypedPullSupplier**, this interface supports:

- Connection and disconnection of pull consumers, exactly as in the generic event channel,
- generic **pull** and **try_pull** operations, and
- obtaining the typed view, so that the consumer can use typed pull communication. The reference returned by **get_typed_supplier** supports the interface identified by the **Key** used when this **TypedProxyPullSupplier** was obtained. (See Section 2.7.2, “The TypedConsumerAdmin Interface,” on page 2-18.)

2.8 Composing Event Channels and Filtering

The event channel administration operations defined in Section 2.3, “The CosEventChannelAdmin Module,” on page 2-8 support the composition of event channels. That is, one event channel can consume events supplied by another. This architecture allows the implementation of an event channel that filters the events supplied by another.

Since the **ProxyPushSupplier** for interface **I** of a typed event channel only pushes events that correspond to **I**, it acts as a filter based on type. Similarly, the **ProxyPullConsumer** for interface **Pull<I>** of a typed event channel only pulls events that correspond to **Pull<I>**, it also acts as a filter based on type.

2.9 Policies for Finding Event Channels

The Event Service does not establish a policy for finding event channels. Finding a service is orthogonal to using the service. Higher levels of software (such as the desktop) can make policies for using the event channel. That is, higher layers will dictate when an event channel is created and how references to the event channel are obtained. By representing the event channel as an object, it has all of the properties that apply to objects, including support by finding mechanisms.

For example, when a user performs a **drag-and-drop** or **cut-and-paste** operation, an event channel could be created and identified to suppliers and consumers. Alternatively, the event channel could be named in a naming context, or it could be exported through an operation on an object.

Lightweight Event Service

3

Note – This chapter is based on the Lightweight Services specification (ptc/04-07-03).

Contents

This chapter contains the following topics.

Topic	Page
“Platform Independent Model”	3-1
“Platform Specific Model: CORBA Service”	3-16

3.1 Platform Independent Model

3.1.1 Overview

This section defines the Platform Independent Model (PIM) for the Lightweight Event Service. The Lightweight Event Service is intended to be a subset of the full CORBA Event Service. The packages, interfaces, and classes appearing in this chapter are intended to model this subset and should map to the IDL for their counterparts in the Event Service Specification (Version 1.1, March 2001). The descriptions of the interfaces, operations and their semantics are also intended to be identical to those defined by the Event Service Specification (Version 1.1, March 2001) over this same subset.

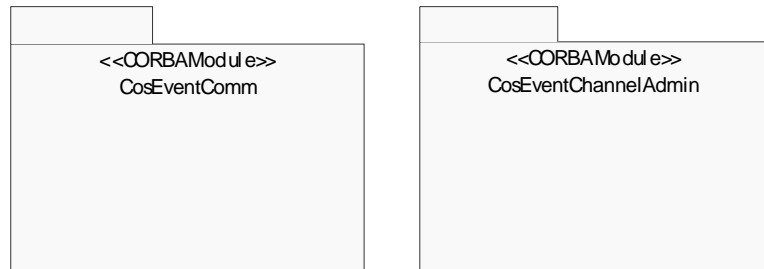

Figure 3-1 - Lightweight Event Service Packages

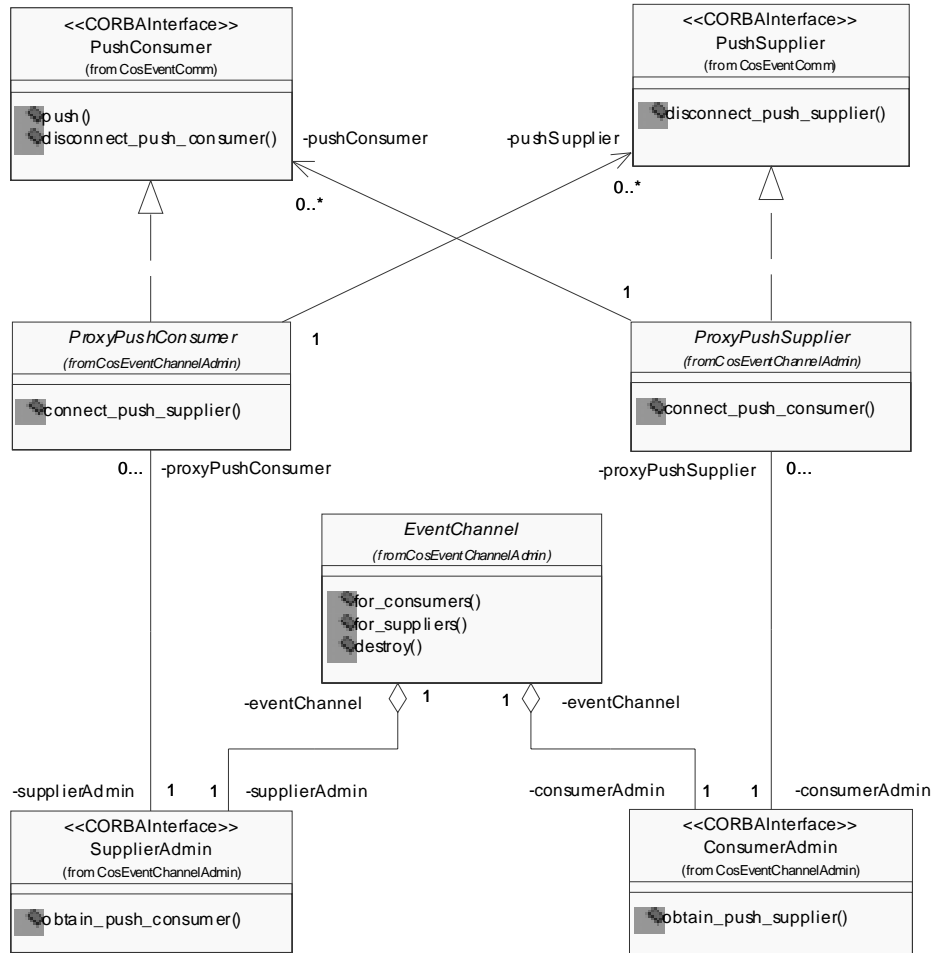

Figure 3-2 - Lightweight Event Service Interfaces and Classes

3.1.2 The CosLightweightEventComm Package

The CosLightweightEventComm package defines the interfaces for push consumers and push suppliers. Only the push model is supported by the Lightweight Event Service.

3.1.2.1 Push Consumer

Description

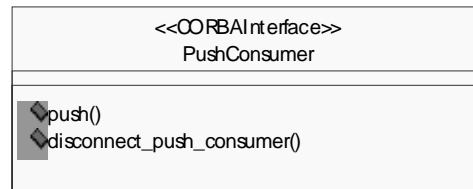

A push-style consumer supports the **PushConsumer** interface to receive event data.

Attributes

No attributes.

Operations

push(in data:Any)

A supplier communicates event data to the consumer by invoking the push operation and passing the event data as an in parameter. The operation raises the exception **Disconnected** if the event communication has already been terminated.

disconnect_push_consumer ()

The **disconnect_push_consumer** operation terminates the event communication; it releases resources used at the consumer to support the event communication. The **PushConsumer** object reference is disposed.

Associations

No associations.

Constraints

No Constraints.

Semantics

Calling **disconnect_push_consumer** causes the implementation to call the **disconnect_push_supplier** operation on the corresponding **PushSupplier** interface (if that interface is known).

3.1.2.2 *Push Supplier*

Description

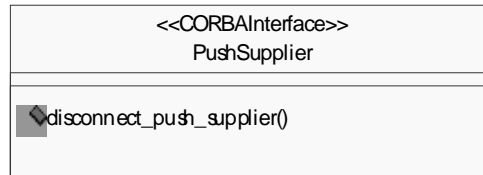

A push-style supplier supports the **PushSupplier** interface.

Attributes

No attributes.

Operations

`disconnect_push_supplier ()`

The **disconnect_push_supplier** operation terminates the event communication; it releases resources used at the supplier to support the event communication. The **PushSupplier** object reference is disposed.

Associations

No associations

Constraints

No Constraints.

Semantics

Calling **disconnect_push_supplier** causes the implementation to call the **disconnect_push_consumer** operation on the corresponding **PushConsumer** interface (if that interface is known).

3.1.2.3 *Disconnected Exception*

Description

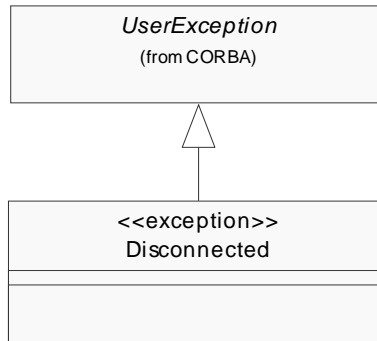

`Disconnected` is the exception raised when an attempt is made to transfer an event after event communication has been terminated. It is a kind of CORBA `UserException`.

Attributes

No attributes.

Operations

No additional operations.

Associations

No association.

Constraints

No constraints.

Semantics

Raised in response to an attempt to push an event after event communication has been terminated. Event communication may be terminated by the operation **`disconnect_push_consumer`**.

3.1.3 *The CosLightweightEventChannel Package*

The **`CosLightweightEventChannelAdmin`** package defines the interfaces for making connections between supplier and consumers. Only the push model is supported by the Lightweight Event Service.

3.1.3.1 EventChannel

Description

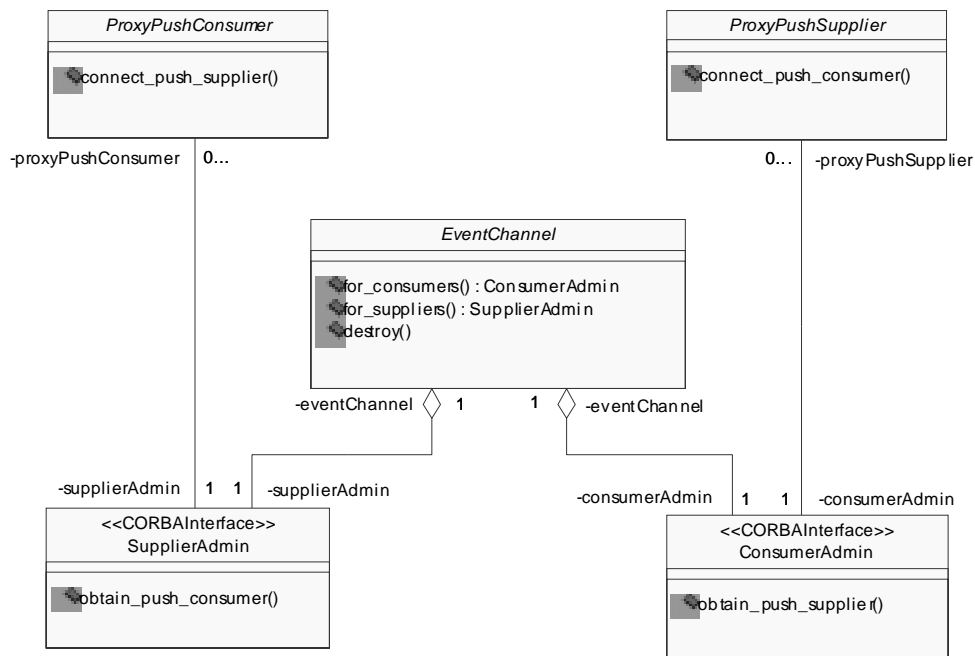

The **EventChannel** interface defines three administrative operations: adding consumers, adding suppliers, and destroying the channel.

Any object that possesses an object reference that supports the **EventChannel** interface can perform the operations listed below.

Consumer administration and supplier administration are defined as separate objects so that the creator of the channel can control the addition of suppliers and consumers. For example, a creator might wish to be the sole supplier of event data but allow many consumers to be connected to the channel. In such a case, the creator would simply export the **ConsumerAdmin** object.

Attributes

No attributes.

Operations

for_consumers(): ConsumerAdmin

The **ConsumerAdmin** interface allows consumers to be connected to the event channel. The **for_consumers** operation returns an object reference that supports the **ConsumerAdmin** interface.

for_suppliers(): SupplierAdmin

The **SupplierAdmin** interface allows suppliers to be connected to the event channel. The **for_suppliers** operation returns an object reference that supports the **SupplierAdmin** interface.

destroy()

The **destroy** operation destroys the event channel.

Associations

supplierAdmin: SupplierAdmin [1]

Each event channel has a single associated **SupplierAdmin** object.

consumerAdmin: ConsumerAdmin [1]

Each event channel has a single associated **ConsumerAdmin** object.

Constraints

No constraints.

Semantics

Destroying an event channel destroys all **ConsumerAdmin** and **SupplierAdmin** objects that were created via that channel. Destruction of a **ConsumerAdmin** or **SupplierAdmin** object causes the implementation to invoke the disconnect operation on all proxies that were created via that **ConsumerAdmin** or **SupplierAdmin** object.

3.1.3.2 ConsumerAdmin

Description

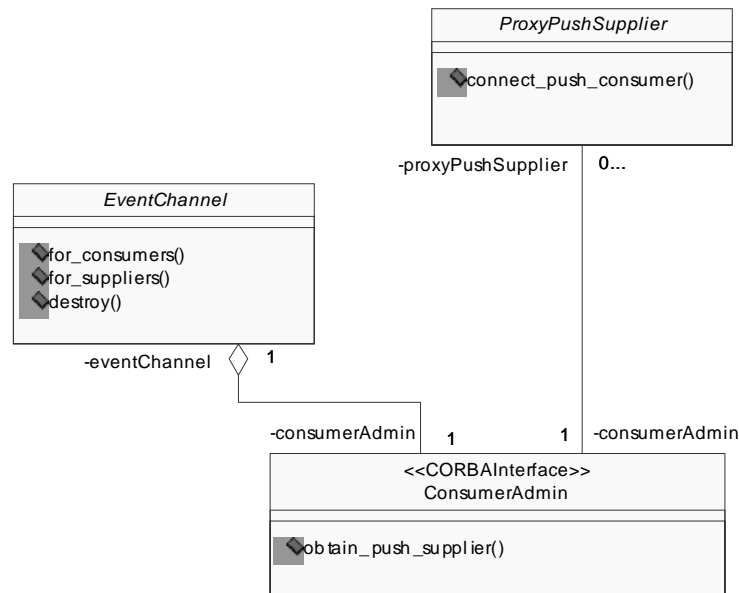

The **ConsumerAdmin** interface defines the first step for connecting consumers to the event channel; clients use it to obtain proxy suppliers.

Attributes

No attributes.

Operations

obtain_push_supplier(): ProxyPushSupplier

The **obtain_push_supplier** operation returns a **ProxyPushSupplier** object. The **ProxyPushSupplier** object is then used to connect a push-style consumer.

Associations

eventChannel: EventChannel [1]

The **EventChannel** object with which the **ConsumerAdmin** object is associated.

proxyPushSupplier: ProxyPushSupplier [0..*]

A proxy push supplier returned by the **obtain_push_supplier** operation.

Constraints

No constraints.

Semantics

The **ConsumerAdmin** interface for the Lightweight Event Service defines only the full Event Service operations need to support the push model of event communication. It provides a logical link between the **EventChannel** object with which it is associated and the **ProxyPushSupplier** object to which consumers connect in order to receive events.

3.1.3.3 SupplierAdmin

Description

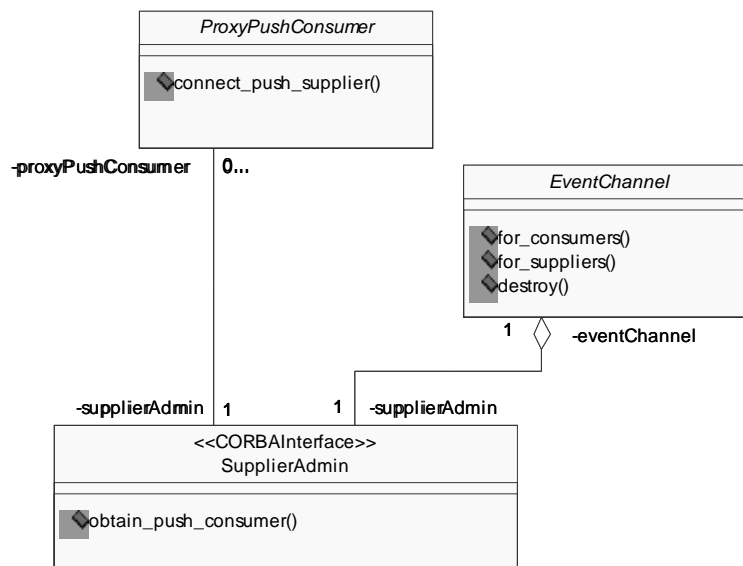

The **SupplierAdmin** interface defines the first step for connecting suppliers to the event channel; clients use it to obtain proxy consumers.

Attributes

No attributes.

Operations

obtain_push_consumer(): ProxyPushConsumer

The **obtain_push_consumer** operation returns a **ProxyPushConsumer** object. The **ProxyPushConsumer** object is then used to connect a push-style supplier.

Associations

eventChannel: EventChannel [1]

The **EventChannel** object with which the **SupplierAdmin** object is associated.

proxyPushConsumer: ProxyPushConsumer [0..*]

A proxy push consumer returned by the **obtain_push_consumer** operation.

Constraints

No constraints.

Semantics

The **SupplierAdmin** interface for the Lightweight Event Service defines only the full Event Service operations needed to support the push model of event communication. It provides a logical link between the **EventChannel** object with which it is associated and the **ProxyPushConsumer** object to which suppliers push events.

3.1.3.4 ProxyPushConsumer

Description

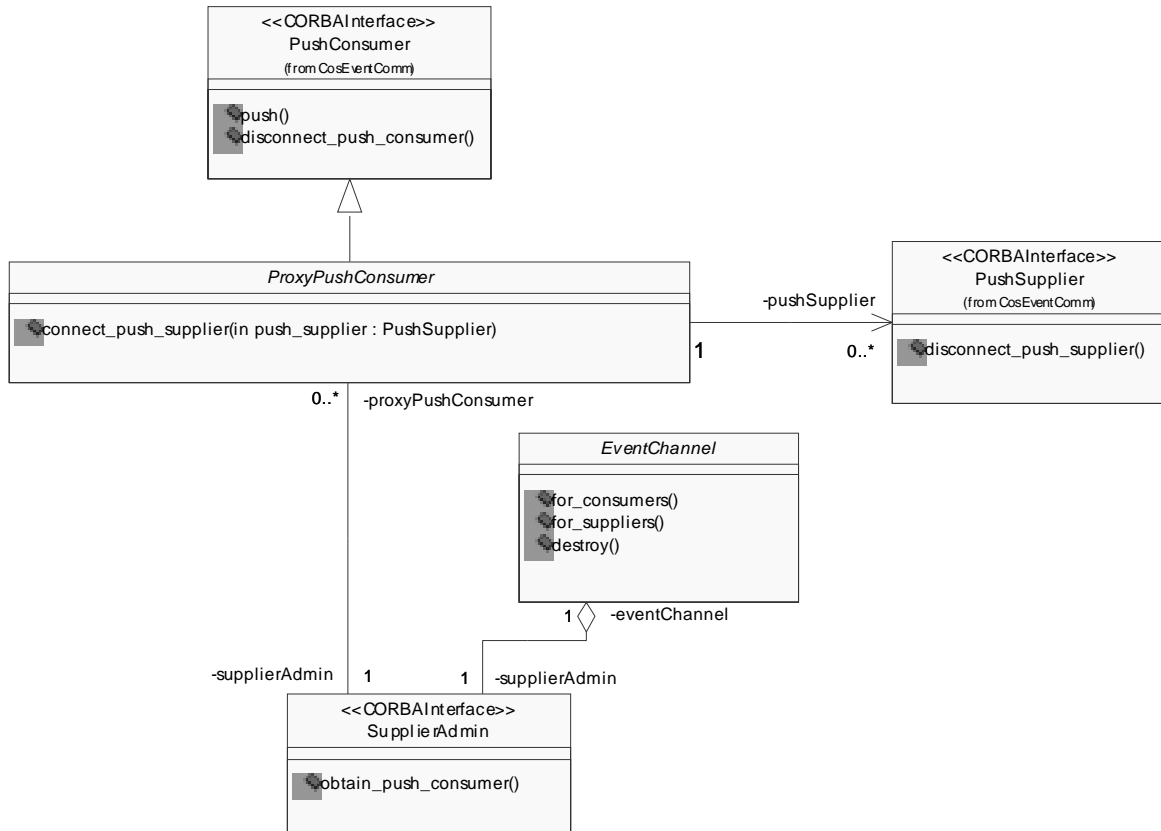

The **ProxyPushConsumer** class defines the second step for connecting push suppliers to the event channel. It realizes the interface defined by **PushConsumer** and extends it to support the connection of push suppliers.

Attributes

No attributes.

Operations

`connect_push_supplier(in pushSupplier: PushSupplier)`

A nil object reference may be passed to the **connect_push_supplier** operation; if so a channel cannot invoke the **disconnect_push_supplier** operation on the supplier; the supplier may be disconnected from the channel without being informed.

If a non-nil reference is passed to **connect_push_supplier**, the implementation calls **disconnect_push_supplier** via that reference when the **ProxyPushConsumer** is destroyed.

If the **ProxyPushConsumer** is already connected to the given **PushSupplier**, then the **AlreadyConnected** exception is raised.

Associations

supplierAdmin: SupplierAdmin [1]

The **SupplierAdmin** object with which the **ProxyPushConsumer** object is associated.

pushSupplier: PushSupplier [0..*]

The **PushSupplier** objects (if any) connected to the **ProxyPushConsumer** object.

Constraints

No constraints.

Semantics

The **ProxyPushConsumer** object acts as a surrogate (proxy) to which suppliers push events.

3.1.3.5 ProxyPushSupplier

Description

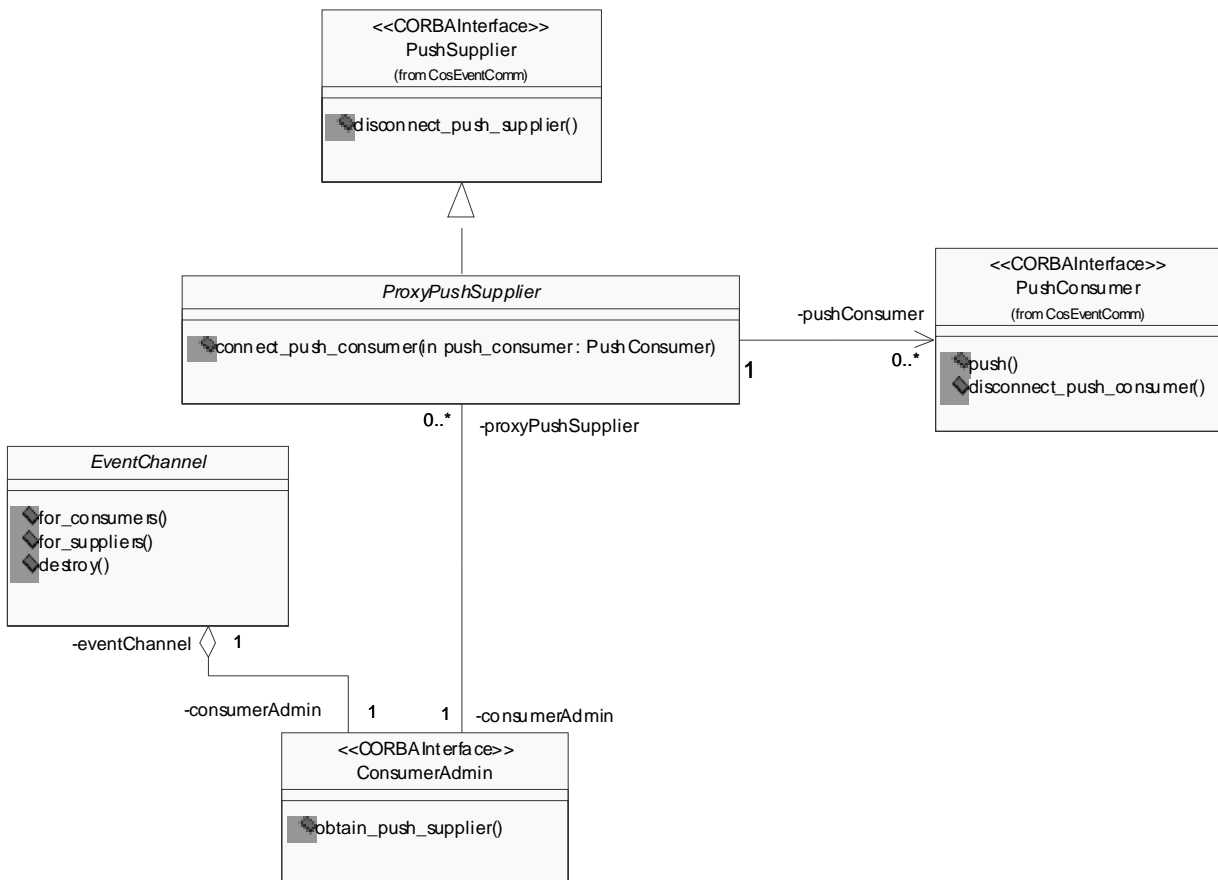

The **ProxyPushSupplier** class defines the second step for connecting push consumers to the event channel. It realizes the interface defined by **PushSupplier** and extends it to support the connection of push consumers.

Attributes

No attributes.

Operations

connect_push_consumer(in pushConsumer: PushConsumer)

Implementations shall raise the CORBA standard **BAD_PARAM** exception if a nil object reference is passed to the **connect_push_consumer** operation.

If the **ProxyPushSupplier** is already connected to the given **PushConsumer**, then the **AlreadyConnected** exception is raised.

Associations

consumerAdmin: ConsumerAdmin [1]

The **ConsumerAdmin** object with which the **ProxyPushSupplier** object is associated.

pushConsumer: PushConsumer [0..*]

The **PushConsumer** objects (if any) connected to the **ProxyPushSupplier** object.

Constraints

No constraints.

Semantics

The implementation calls **disconnect_push_consumer** on the reference passed to **connect_push_consumer** when the the **ProxyPushSupplier** is destroyed.

3.1.3.6 *AlreadyConnected Exception*

Description

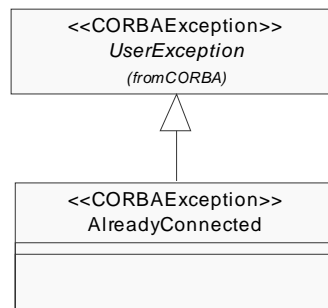

AlreadyConnected is the exception raised when an attempt is made to connect a consumer/producer to a proxy that is already has a connection to the same object. It is a kind of CORBA **UserException**.

Attributes

No attributes.

Operations

No additional operations.

Associations

No associations.

Constraints

No constraints.

Semantics

Raised if an attempt is made to connect a **PushConsumer** object to a **ProxyPushSupplier** object when the two are already connected, or when an attempt is made to connect a **PushSupplier** object to a **ProxyPushConsumer** object when the two are already connected.

3.2 Platform Specific Model: CORBA Service

3.2.1 Overview

The following sections specify a platform specific mapping of the Lightweight Event Service onto the CORBA platform. The resulting CORBA service is specified in CORBA IDL and represents a fully compatible subset of the **CosEventService**.

3.2.2 CosEventChannelAdmin Module

```
#include <CosEventComm.idl>
#pragma prefix "omg.org"
module CosEventChannelAdmin {
# ifdef _PRE_3_0_COMPILER_
  typeprefix "omg.org";
# endif // _PRE_3_0_COMPILER_

  exception AlreadyConnected {};
  exception TypeError {};
```

3.2.2.1 ProxyPushConsumer

```
interface ProxyPushConsumer: CosEventComm::PushConsumer {
  void connect_push_supplier(
    in CosEventComm::PushSupplier push_supplier)
    raises(AlreadyConnected);
};
```

3.2.2.2 ProxyPushSupplier

```
interface ProxyPushSupplier: CosEventComm::PushSupplier {
  void connect_push_consumer(
    in CosEventComm::PushConsumer push_consumer)
```

```

        raises(AlreadyConnected, TypeError);
    };

```

3.2.2.3 *ConsumerAdmin*

```

    interface ConsumerAdmin {
        ProxyPushSupplier obtain_push_supplier();
    };

```

3.2.2.4 *SupplierAdmin*

```

    interface SupplierAdmin {
        ProxyPushConsumer obtain_push_consumer();
    };

```

3.2.2.5 *EventChannel*

```

    interface EventChannel {
        ConsumerAdmin for_consumers();
        SupplierAdmin for_suppliers();
        void destroy();
    };
};
#endif /* ifndef _COS_EVENT_CHANNEL_ADMIN_IDL_ */

```

3.2.3 *CosEventComm Module*

```

//File: CosEventComm.idl
//Part of the Event Service

#ifndef _COS_EVENT_COMM_IDL_
#define _COS_EVENT_COMM_IDL_
#pragma prefix "omg.org"
module CosEventComm
{
    # ifndef _PRE_3_0_COMPILER_
        typeprefix "omg.org";
    # endif // _PRE_3_0_COMPILER_

    exception Disconnected{};
};

```

3.2.3.1 *PushConsumer*

```

    interface PushConsumer
    {
        void push (in any data) raises(Disconnected);
    };

```

```
        void disconnect_push_consumer();  
    };
```

3.2.3.2 *PushSupplier*

```
    interface PushSupplier  
    {  
        void disconnect_push_supplier();  
    };  
};  
#endif /* ifndef _COS_EVENT_COMM_IDL_ */
```

Implementing Typed Event Channels A

A.1 Introduction

Note – Implementation details do not form part of an OMG specification, and should not be standardized. On the other hand, it is not obvious that typed channels can be implemented without extensions to CORBA. This section indicates *one* strategy for implementing typed event channels. It is included to show that typed event channels can be implemented; it is not intended in any way to constrain implementations. Optimized implementations are certainly possible.

Figure A-1 demonstrates a possible implementation of a typed event channel. This appendix concentrates on push style communication. The implementation of pull-style communication is analogous.

The implementation interposes an *encoder* between typed-style suppliers and the channel and a *decoder* between the channel and typed-style consumers.

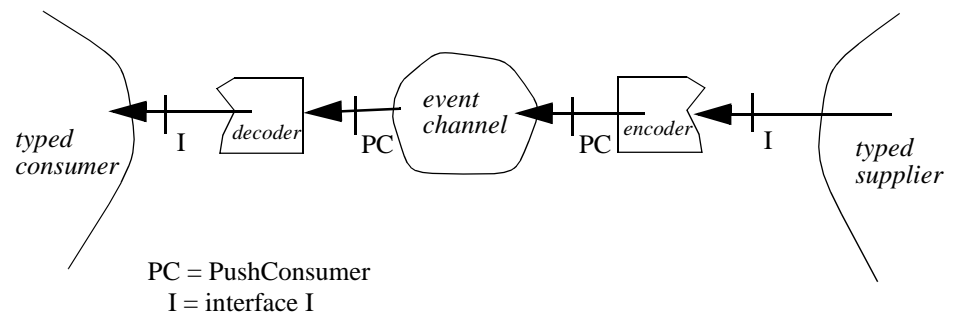

Figure A-1 A possible implementation of a typed event channel.

At the supplier end, an *encoder* converts operation calls to **push** calls.

At the consumer end, a *decoder* converts **push** calls back to operation calls.

The effect of such a communication is thus that the original operation is eventually called on the consumer, but the communication is routed via the channel. Of course, there can be multiple suppliers and multiple consumers on the same channel. Whenever one of the suppliers calls an operation, it is delivered by the channel to all consumers.

The encoder must package the operation identification and the parameters in a manner that the decoder can unpack them correctly.

Given the OMG IDL definition of an interface, **I**, an encoder generator could generate an implementation that supports the interface **I** and converts all calls on this interface to **push** calls on an event channel.

Similarly, it is possible to generate an I-decoder from the OMG IDL definition of **I**.

The typed event channel is responsible for finding, creating, or implementing the appropriate encoders. An appropriate encoder is found or created in response to the **obtain_typed_push_consumer** request on the typed event channel. The encoder is returned in response to the **get_typed_consumer** request.

Similarly, the typed event channel is responsible for finding, creating, or implementing the appropriate decoders. An appropriate decoder is found or created in response to the **connect_push_consumer** request on the typed event channel.

An Event Channel Use Example

B

This section illustrates an example use of the event channel, including the following:

- Creating an event channel.
- Consumers and/or suppliers finding the channel.
- Suppliers using the event channel.
- In this example, the document object creates event channels and defines operations in its interface to allow consumers to be added.
- The **Document** interface defines two operations to return event channels:

```
interface Document {  
  
    ConsumerAdmin title_changed();  
  
    ConsumerAdmin new_section();  
  
    :  
  
};
```

The **title_changed** operation causes the document to generate an event when its title is changed; the **new_section** operation causes the document to generate an event when a new section is added. Both operations return **ConsumerAdmin** object references. This allows consumers to be added to the event channel.

-
- The **title_changed** implementation contains instance variables for using and administering the event channels.

```
/* Factory for creating event channels. */  
EventChannelFactoryRef  ecf;  
  
/* For title changed event channel */  
EventChannelRef         event_channel;  
  
ConsumerAdminRef       consum_admin;  
SupplierAdminRef       supplier_admin;  
  
ProxyPushConsumerRef  proxy_push_consumer;  
PushSupplierRef       doc_side_connection;
```

- At some point, the document implementation creates the event channel, gets supplier and consumer administrative references, and adds itself as a supplier¹.

```
event_channel = ecf->create_eventchannel(env);  
  
supplier_admin = event_channel->for_suppliers(env);  
consumer_admin = event_channel->for_consumers(env);  
proxy_push_consumer = supplier_admin->obtain_push_consumer(env);  
  
proxy_push_consumer->connect_push_supplier(env,  
                                           doc_side_connection)
```

- The **title_changed** operation returns the **ConsumerAdmin** object reference.

```
return consumer_admin;
```

Clients of this operation can add consumers.

- When the title changes, the document implementation pushes the event to the channel.

```
proxy_push_consumer->push(env,data);
```

The document implementation similarly initializes, exports, and uses the event channel for reporting new sections.

1. For readability, exception handling is omitted from these code fragments.

- A**
application object 1-2
- C**
callback interface
 described viii
common facilities iv
compound object vii
concepts of vi
connect 2-11
Consolidated OMG IDL A-1, B-1
consumer 1-2
ConsumerAdmin interface 2-9, 2-10, 2-18
 for_consumers operation 2-9
 obtain_pull_supplier operation 2-10
 obtain_push_supplier operation 2-10
CORBA vi
 contributors ix
 documentation set v
 standard requests 1-1
CORBA OMG IDL based Specification of the Trading
 Function A-1, B-1
CosEventChannelAdmin module
 OMG IDL 2-8–2-9
CosEventComm module
 OMG IDL 2-1
CosTypedEventComm module
 OMG IDL 2-14
- E**
event channel vii, viii, 1-5, 2-6
 adding consumers 2-9
 adding consumers to 2-10
 adding consumers to typed 2-18
 adding pull consumer to typed 2-20
 adding pull consumers to 2-11
 adding pull suppliers to 2-11
 adding push consumers to 2-12
 adding push suppliers to 2-10
 adding push suppliers to typed 2-19
 adding suppliers 2-9
 adding suppliers to 2-10
 adding suppliers to typed 2-19
 and CORBA requests 2-4
 decoders A-2
 defined 1-3, 2-4
 encoders A-2
 filtering 2-20–2-21
 implementing typed A-1–A-2
 sample use B-1–B-2
event communication
 mixed 2-5
 multiple 2-6
 pull model 1-2, 1-7, 2-5
 push model 1-2, 1-7, 2-4
 typed pull model 2-13
 typed push model 2-12
event consumer 1-2, 1-7, 2-4
 proxy 2-7
event service
 and CORBA scoping 1-5
 overview 1-1
event supplier 1-2, 1-7, 2-4
 proxy 2-7
EventChannel interface vii, 2-6, 2-7, 2-9
exception 2-19
exceptions
 described ix
- G**
global identifier viii
- I**
interface inheritance.see subtyping
- O**
Object Management Group iii
 address of vi
object model v
object request broker iv, v
object service
 context iv
 specification defined v
OMG IDL v, vii
- P**
property list 1-2
ProxyPullConsumer interface 2-11
 connect_pull_supplier operation 2-11
ProxyPullSupplier 2-11
ProxyPullSupplier interface 1-3, 2-11
 connect_pull_consumer operation 2-11
ProxyPushConsumer interface 1-3, 2-10
 connect_push_supplier operation 2-11
 disconnect_push_supplier operation 2-11
ProxyPushSupplier interface 2-12
 connect_push_consumer operation 2-12
PullConsumer interface 1-3, 2-3, 2-14
 disconnect_pull_consumer operation 1-7
PullSupplier interface vii, 1-7, 2-3
 disconnect_pull_supplier operation 1-7, 2-3
 pull operation 2-3
 try_pull operation 2-3
PushConsumer interface vii, 1-7, 2-2
 disconnect_push_consumer operation 2-2
 push operation 2-2
PushSupplier interface 1-3, 2-2
 disconnect_push_supplier operation 1-7, 2-3
- Q**
quality of service vii, 1-4, 1-6, 2-6
- R**
reference model iv
- S**
subtyping vi, ix
supplier 1-2
SupplierAdmin interface 1-3, 2-9, 2-10
 for_suppliers operation 2-9
 obtain_pull_consumer operation 2-10
 obtain_push_consumer operation 2-10

Index

- T**
TypedConsumerAdmin interface
 obtain_typed_pull_supplier operation 2-18
 obtain_typed_push_supplier operation 2-18
TypedProxyPullSupplier interface 2-20
TypedProxyPushConsumer interface 2-19
TypedPullSupplier interface 2-14
- TypedPushConsumer interface 2-13
TypedSupplierAdmin interface 2-19
 obtain_typed_pull_consumer operation 2-19
 obtain_typed_push_consumer operation 2-19
- X**
X/Open iv